

130H3P3568A3

电机尺寸
DIMENSIONS:
(UNIT=MM)

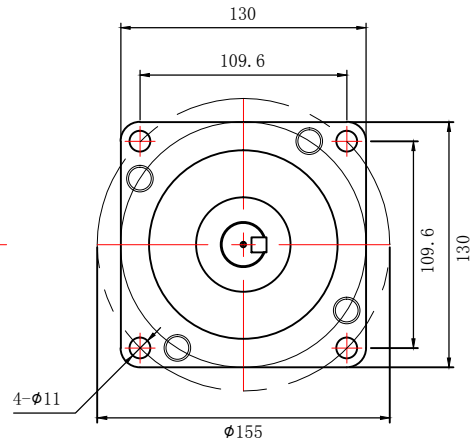

电机接线图
WIRING DIAGRAM:

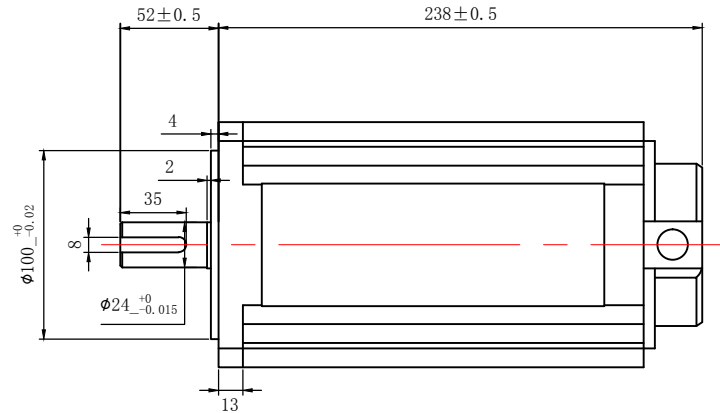
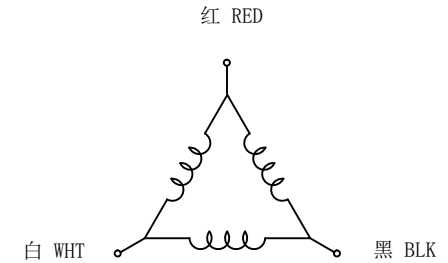

说明
NOTES:

- PLEASE DON'T HOLD MOTOR BY LEAD WIRES.
- PLEASE DON'T PLUG IN/OUT THE MOTOR CONNECTOR WHILE POWER ON.
- PLEASE DON'T DROP, HURL OR DUMP MOTOR AGAINST HARD MATERIAL
MALFUNCTION MAY NOT BE OBSERVED AT EARLY STAGE AFTER SUCH SHOCKS, BUT FOUND LATER. THE MISHANDLING VOIDS OUR WARRANTY.
- DONGGUAN ICAN-TECH WILL NOT BE RESPONSIBLE FOR ANY PATENT DISPUTE OR PROBLEM CAUSED BY ACTUAL APPLICATIONS

驱动连接方式
CONNECTION MODE:

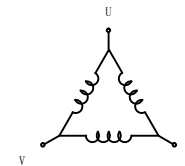

备注：电机三根线分别接入驱动器U、V、W端子，调换任意两根电机接线，可改变电机的运行方向

电机参数/ELECTRICAL PARAMETER		轴径配置/SHAFT DESIGN
电机型号 MANUFACTURER MODEL	130H3P3568A3	
适配步进电机驱动器 MATCHED MOTOR DRIVE	3MC8H	
步距角 STEP ANGLE (° /STEP)	1.2	
电机电压 RATED VOLTAGE (V)	220	
电机电流 RATED CURRENT (A/PHASE)	6.8	
电机电阻 RESISTANCE (Ω±15%/PHASE)	0.97	
电机电感 INDUCTANCE (mH+20%/PHASE)	14.2	
电机力矩 HOLDING TORQUE (N.M)	35	
电机绝缘等级 INSULATION CLASS	B	

制图 DESIGNED	检图 CHECKED	校准 APPROVED	日期 DATE	比例 SCALE
HUANGTING	MAHUALING		2016/03/01	1:4
130H3P3568A3		东莞市一能机电技术有限公司 DONGGUAN ICAN TECHNOLOGY CO., LTD		
三相步进电机 THREE-PHASE STEPPING MOTOR				版本 EDITION V2.0