

60BLF-1630NBB

电机尺寸
DIMENSIONS:
(UNIT=MM)

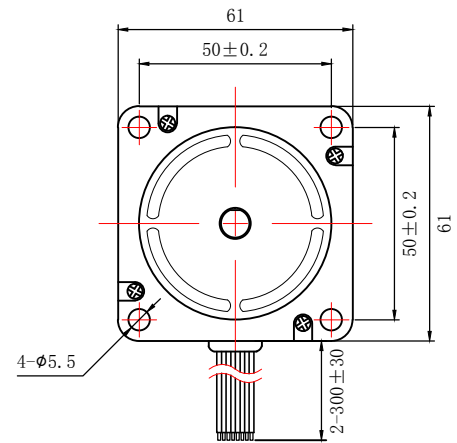
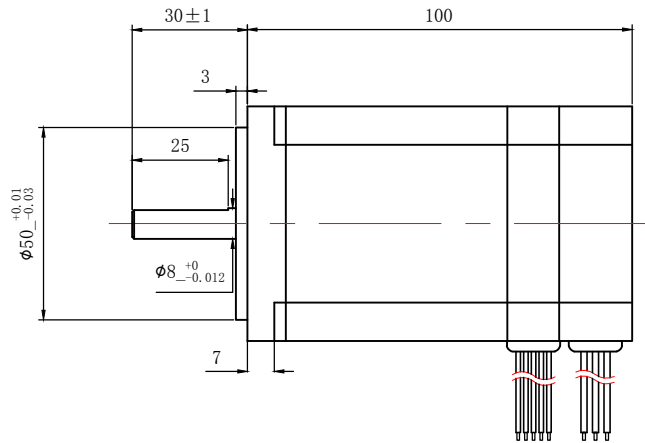

NOTES:

- PLEASE DON'T HOLD MOTOR BY LEAD WIRES.
- PLEASE DON'T PLUG IN/OUT THE MOTOR CONNECTOR WHILE POWER ON.
- PLEASE DON'T DROP, HURL OR DUMP MOTOR AGAINST HARD MATERIAL
MALFUNCTION MAY NOT BE OBSERVED AT EARLY STAGE AFTER SUCH SHOCKS, BUT FOUND LATER. THE MISHANDLING Voids OUR WARRANTY.
- DONGGUAN ICAN-TECH WILL NOT BE RESPONSIBLE FOR ANY PATENT DISPUTE OR PROBLEM CAUSED BY ACTUAL APPLICATIONS

驱动连接方式
CONNECTION MODE:

连接方式 CONNECTION MODE	MOTOR CABLES 3"UL3265 AWG22#			HALL SENSOR CABLES 5"UL1007 AWG26#				
电机线 MOTOR LINE	粗黄	粗绿	粗蓝	细黄	细绿	细蓝	细黑	细红
驱动器接口 DRIVER INTERFACE	U	V	W	HU	HV	HW	REF-	REF+

制图 DESIGNED	检图 CHECKED	校准 APPROVED	日期 DATE	比例 SCALE
HUANG TING	MA HUALING		2015/03/01	1:2
60BLF-1630NBB		东莞市一能机电技术有限公司 DONGGUAN ICAN TECHNOLOGY CO., LTD		
直流无刷电机 BRUSHLESS DC MOTOR			版本 EDITION V2.0	

电机参数/ELECTRICAL PARAMETER		轴径配置/SHAFT DESIGN
电机型号 MANUFACTURER MODEL	60BLF-1630NBB	
适配直流无刷电机驱动控制器 MATCHED MOTOR DRIVE	BLD300B/BLD750	
额定功率 RATED POWER (W)	160	
额定转速 RATED SPEED (RPM±10%)	3000	
电机电压 RATED VOLTAGE (V)	24	
电机电阻 RESISTANCE (Ω±15%)	0.22	
电机电感 INDUCTANCE (mH±20%)	0.29	
电机力矩 HOLDING TORQUE (N.M)	0.5	
磁极数 NUMBER OF POLES	8	