

57H2P9850A4

电机尺寸  
DIMENSIONS:  
(UNIT=MM)

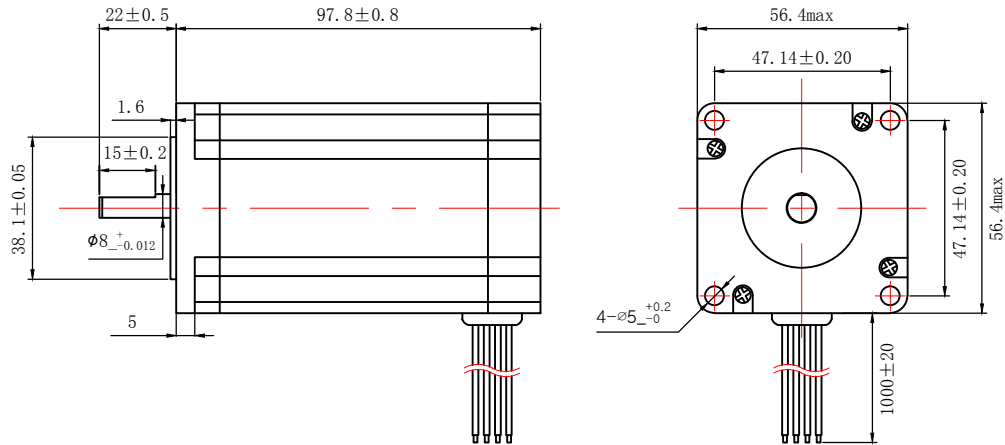

电机接线图  
WIRING DIAGRAM:

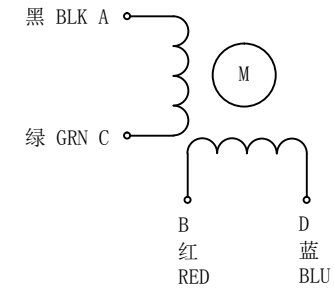

说明  
NOTES:

- PLEASE DON'T HOLD MOTOR BY LEAD WIRES.
- PLEASE DON'T PLUG IN/OUT THE MOTOR CONNECTOR WHILE POWER ON.
- PLEASE DON'T DROP, HURL OR DUMP MOTOR AGAINST HARD MATERIAL  
MALFUNCTION MAY NOT BE OBSERVED AT EARLY STAGE AFTER SUCH SHOCKS, BUT FOUND LATER. THE MISHANDLING VOIDS OUR WARRANTY.
- DONGGUAN ICAN-TECH WILL NOT BE RESPONSIBLE FOR ANY PATENT DISPUTE OR PROBLEM CAUSED BY ACTUAL APPLICATIONS

驱动连接方式  
CONNECTION MODE:

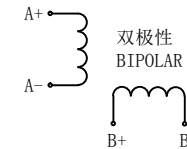

电机参数/ELECTRICAL PARAMETER		轴径配置/SHAFT DESIGN
电机型号 MANUFACTURER MODEL	57H2P9850A4	
适配步进电机驱动器 MATCHED MOTOR DRIVE	MR4/MR5	
步距角 STEP ANGLE (° /STEP)	1.8	
电机电压 RATED VOLTAGE (V)	4.2	
电机电流 RATED CURRENT (A/PHASE)	4.5	
电机电阻 RESISTANCE (Ω±15%/PHASE)	0.7	
电机电感 INDUCTANCE (mH±20%/PHASE)	2.4	
电机力矩 HOLDING TORQUE (N.M)	2.6	
电机绝缘等级 INSULATION CLASS	B	

制图 DESIGNED	检图 CHECKED	校准 APPROVED	日期 DATE	比例 SCALE
HUANGTING	MAHUALING		2016/03/01	1:1.8
<b>57H2P9850A4</b>		东莞市一能机电技术有限公司 DONGGUAN ICAN TECHNOLOGY CO., LTD		
两相步进电机 TWO-PHASE STEPPING MOTOR				版本 EDITION V2.0