

BLD-120A

Brushless dc motor driver



1 Brief introduction

BLD 120A is designed by ICAN-Tech and mainly for low power low voltage BLDC motor. Motors less than 70w are adaptive.

1.1 Features

- Acc/Dec time setting
- Max output current P-sv setting
- Restart
- Alarm signal
- Built-in RV speed setting
- External potentiometer speed setting
- External analog signal speed setting
- PWM speed setting

2 Electrical properties and environmental indicators

2.1 Electrical properties

Driver parameter	Min Value	Typical Value	Max Value
Voltage input DC (V)	12	24	30
Current output(A)	-	-	8
Motor speed range(rpm)	0	-	20000
Hall signal voltage(V)	-	-	5
Hall drive current (mA)	-	20	-
External potentiometer(KΩ)	-	10	-

2.2 Environmental indicators

Heat Sinking Method	Natural cooling or fan-forced cooling
Atmosphere	Avoid dust, oily mist and corrosive air
Operating Temperature	0 ~ +40°C
Ambient Humidity	90% or less (non-condensing)
Vibration Resistance	5.7m/s ² maximum
Storage Temperature	0 ~ +50°C

3 Dimension (Unit: mm)

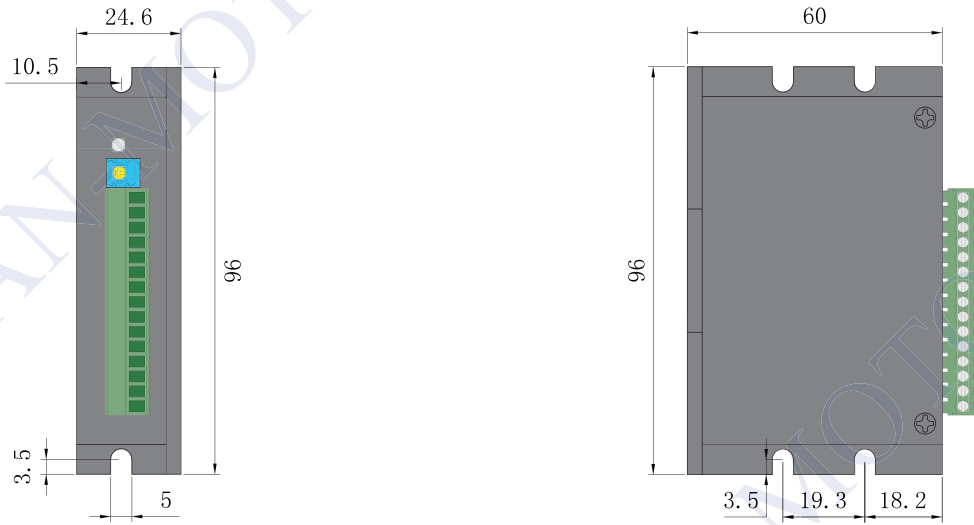

4 Driver interface and wiring diagram

4.1 Driver interface

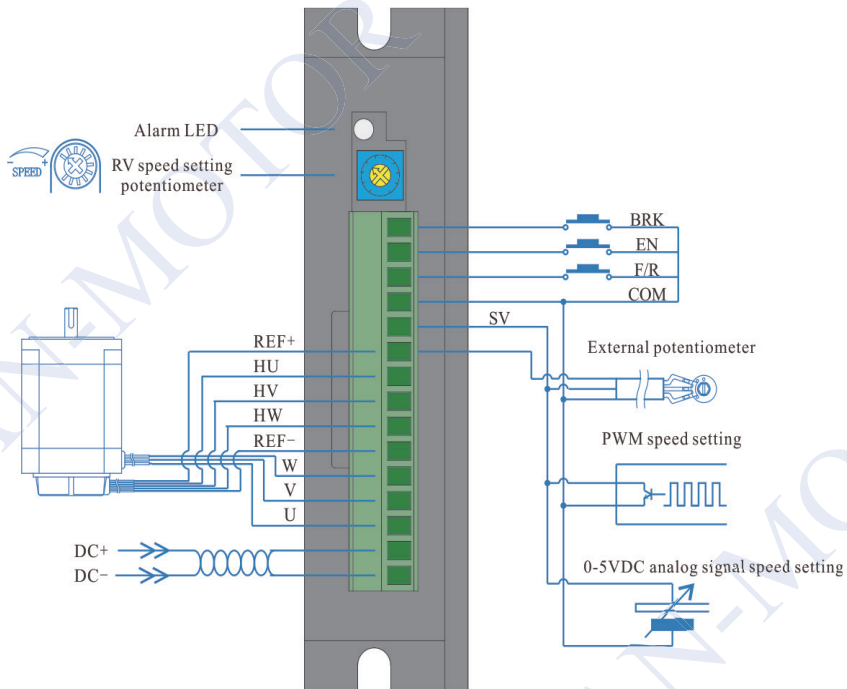

4.2 Port signal description

Signal category	Terminal	Functional Description
Control signal	BRK	Motor brake stop control signal; BRK and COM connect in default, motor brake stops when BRK and COM disconnect.
	EN	Stop signal terminal; EN connects COM, motor runs, otherwise motor stops.
	F/R	Motor direction control terminal; F/R and COM disconnect, motor will rotate clockwise, and otherwise, motor will rotate anticlockwise.
	COM	Common port(0V)
	SV	① External potentiometer speed setting input; ② External analog voltage input terminal ③ PWM speed setting input
Hall signal	REF+	Hall sensor signal power supply+
	HU	Hall sensor signal Hu
	HV	Hall sensor signal Hv
	HW	Hall sensor signal Hw
	REF-	Hall sensor signal-
Motor connection	W	Motor line W phase
	V	Motor line V phase
	U	Motor line U phase
Power connection	DC+	Power supply positive electrode (12-30VDC)
	DC-	Power supply negative electrode (Hall sensor negative electrode)

5 Function setting

5.1 ACC/DEC time setting

Set acceleration time and deceleration time by ACC/DED, range is 0.3-15s. Acceleration time is time needed from 0 to rated speed. Deceleration time is time needed from rated speed to 0. Ti

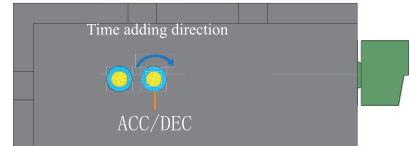



5.2 Peak current setting

Use P-sv to set the output peak current. When load is increased suddenly, the output current will be limited by the setting value, which reduces motor speed and protects the motor. Current setting ranges: 1.6-8A.

Please set as the right.

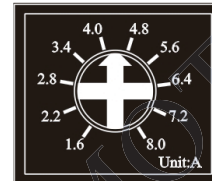
As the admissible error of real current and setting value is $\pm 10\%$, to ensure safety, set current lower accordingly.



 The duration of peak current is 3s when load increases suddenly. After 3s, of load is not reduced, driver will stop working. After 5s, it restarts automatically.

Notice

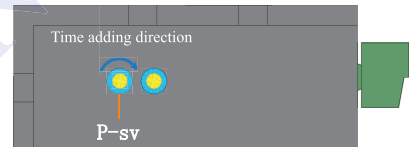

5.3 Stall current setting

When motor stalls, the output current will be the set max value, which protects driver and motor from damage.

5.4 Stalling torque holding

When motor stalls, torque will be kept in short time.

 This feature can't be used for brake stalling.

Notice

5.5 Restart function

When stalling occurs, driver stops working, after 5s, it restarts. If fault occurs again, alarm signal will be sent out and driver stop working.

5.6 Motor start and stop

Motor start and stop

EN and COM terminal is short circuit in default. When power is on, driver will drive motor automatically. If EN disconnects with COM, motor stops.

◆ To add a switch or PLC between COM and EN can control the motor start and stop.

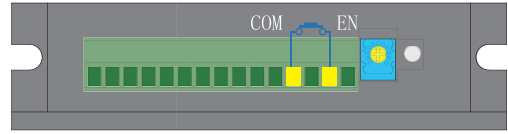

Brake

BRK and COM terminal disconnect in default. Motor will brake stop if BRK and COM are in short circuit.

◆ To add a switch or PLC between COM and BRK can control the motor start and stop.

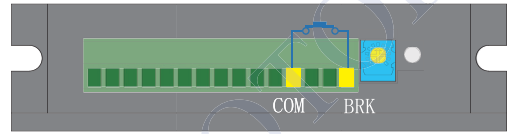

Difference between EN and BRK

1. EN is for stop naturally, BRK is for stop suddenly.

Notice 2. EN and BRK have the same startup state

3. When selecting one of the modes, another mode must be kept as default setting.

5.7 Direction control

F/R and COM disconnect in default, when power is on, motor will start to run clockwise.

Connect F/R and COM, the motor will rotate anticlockwise, otherwise, the motor will rotate clockwise

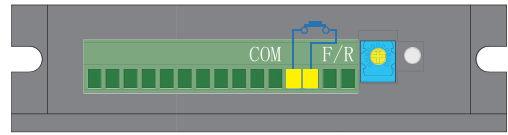

The direction is judged from the quarter view of the axle.

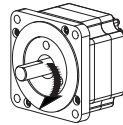

6 Speed setting methods and setting

6.1 Speed setting via built-in potentiometer

Motor speed increases when RV knobs is rotated clockwise, when anticlockwise, motor speed decreases.



If customers use other speed modes, RV should be rotated anticlockwise to limit position.

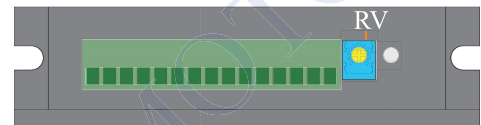

6.2 Speed setting via external potentiometer

Use a suitable potentiometer with a resistance value of 10KΩ; when connect external potentiometer, the middle terminal connects to SV, the other two terminals connect to REF+ and COM.

Notice: 1. RV should be rotated anticlockwise to limit position.



① RV should be rotated anticlockwise to limit position.

Notice ② Notice the order of connection of potentiometer.

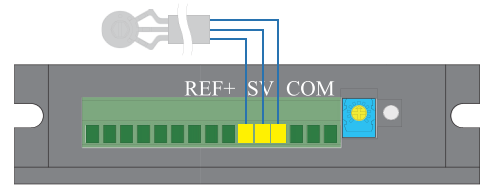

6.3 Speed setting via external analog signal 0-5V

Relational graph between the analog signal voltage and the motor speed (no load)

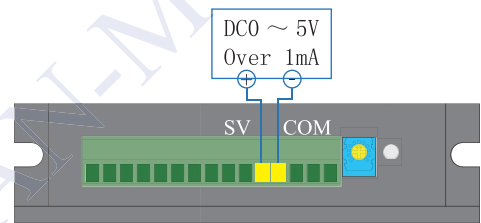
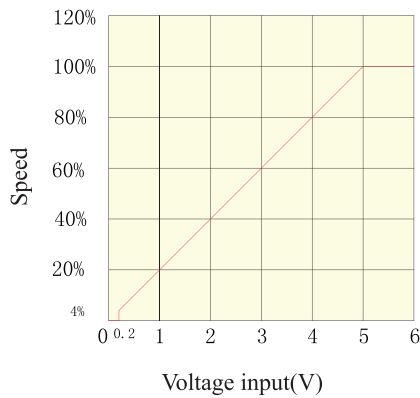

RV should be rotated anticlockwise to limit position.

Notice

The analog signal voltage can be 0 ~ 5VDC; when the voltage is 0.2VDC, the motor speed reaches 4% of fastest speed; when the voltage is 5 VDC, the motor speed reaches maximum value, which depends on the motor specification and power voltage.

6.4 PWM Speed setting

Relational graph between duty ratio and the motor speed(no load)

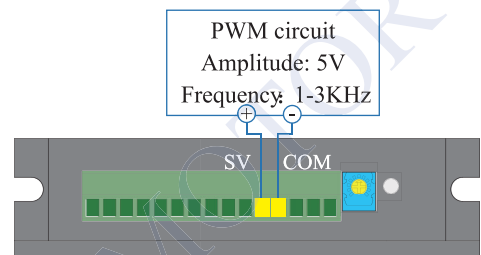
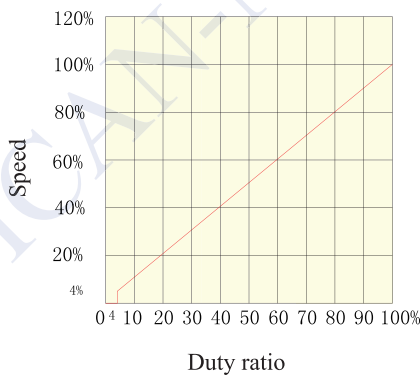

RV should be rotated anticlockwise to limit position.



Notice

When duty ratio of pulse is 4%, motor speed is 4% of max speed, when duty ratio is 100%, motor reaches max speed. The max speed also depends on the motor specification and power voltage.

7 Status indicator. Exceptional handling

7.1 Status indicator

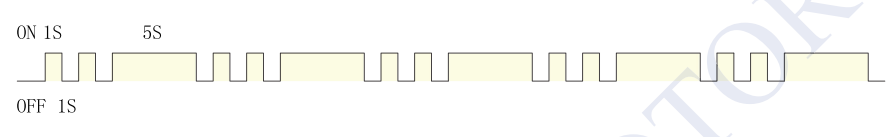
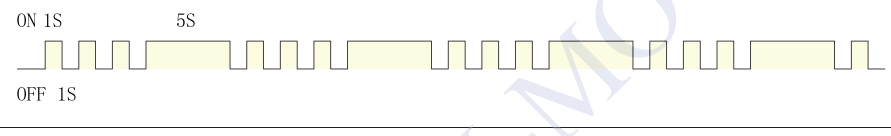
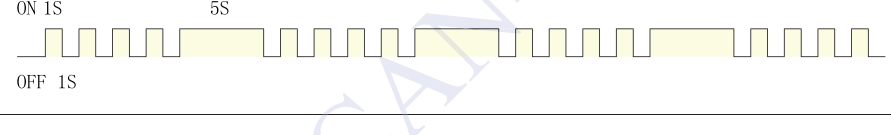
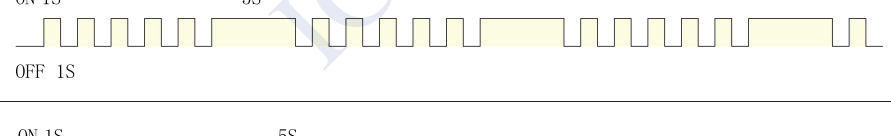
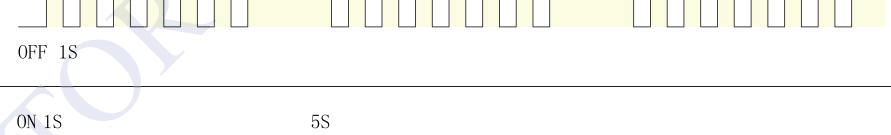
When over-current, Hall fault, over-temperature, and over voltage occurs, driver will give an alarm signal, and ALM terminal and COM will be in short circuit, ALM terminal will be changed to low level. Motor driver stop working, alarm LED flashes.

Led error display	Status statements	LED display
Red Led flashes twice	Over voltage	
Red Led flashes three times	Tube over current	
Red Led flashes four times	Over current	
Red Led flashes five times	Low voltage	
Red Led flashes six times	Hall error	
Red Led flashes seven times	Locked-rotor	
Red Led flashes eight times	Over two errors	

7.2 Exceptional handling

Led error display	Status statements	Solution
Red Led flashes twice	Over voltage	Check the bus voltage
Red Led flashes three times	Tube over current	Ensure model selection is right
Red Led flashes four times	Over current	Check P-sv setting and motor parameter.
Red Led flashes five times	Low voltage	Increase the acceleration time Check power voltage, and ensure power supply is 1.5times of motor power.
Red Led flashes six times	Hall error	Ensure motor connection is well
Red Led flashes seven times	Locked-rotor	Check if motor is overload
Red Led flashes eight times	Over two errors	Hall error or locked-rotor. When speed setting is not available, set P-sv to max value

8 Matched motor

The following recommended motors are matched with BLD-120. They have stable speed, large torque, low noise and low vibration.

- 57mm*57mm round BLDC Motor
- Electrical specification

Model	output power (W)	Voltage (VDC)	Rated speed (RPM)	Rated torque (Nm)	Motor length (mm)
57BLY-0730NBB	69	24	3000	0.22	66.5
57BLY-1030NBB	103	24	3000	0.33	87
57BLY-1230NBB	125	24	3000	0.44	106.5

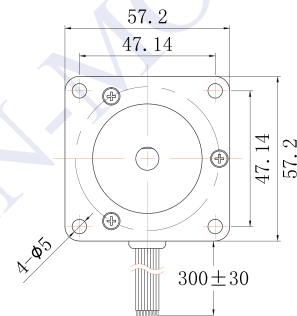
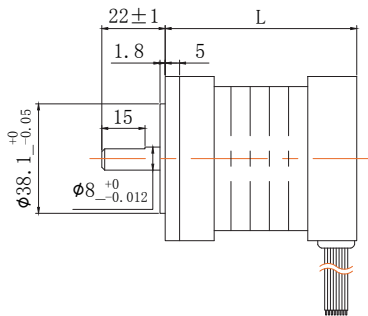

- Torque curve

57BLY-0730NBB

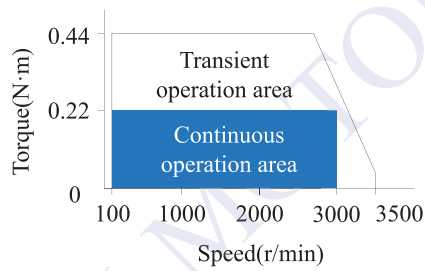

57BLY-1030NBB

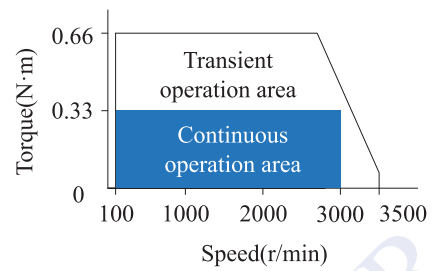

57BLY-1230NBB

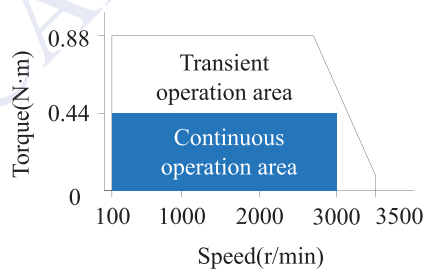

- 57mm*57mm square BLDC Motor
- Electrical specification

Model	output power (W)	Voltage (VDC)	Rated speed (RPM)	Rated torque (Nm)	Motor length (mm)
57BLF-0615NBB	65	24	1500	0.40	82
57BLF-0730NBB	65	24	3000	0.22	62
57BLF-1230NBB	125	24	3000	0.40	80

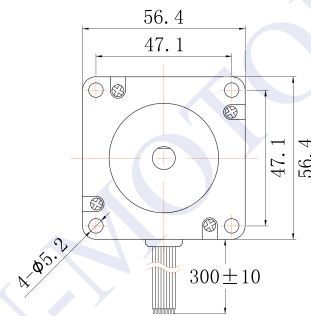
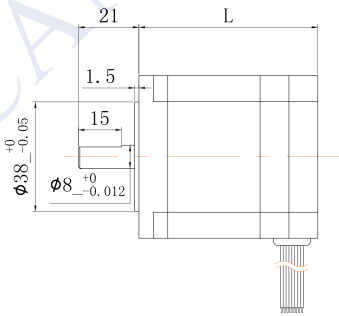

- Torque curve

57BLF-0615NBB

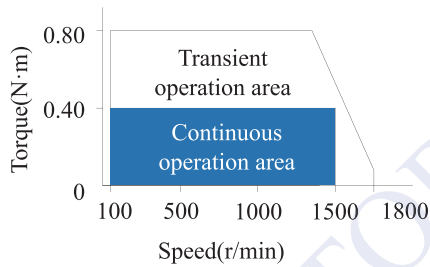

57BLF-0730NBB

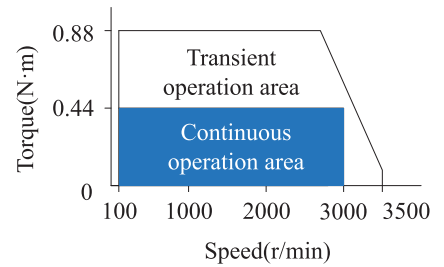

57BLF-1230NBB

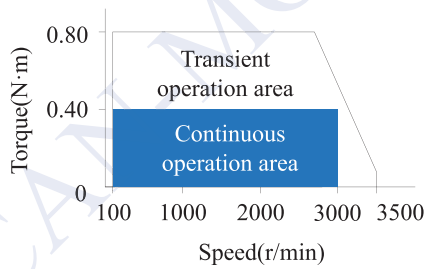

9 After sale service

9.1 Warranty period

Dongguan ICAN Technology provides warranty for 1 year from the date of shipping.

9.2 Return policy

- After-use or man-made damage condition (etc, wrong wiring), no return.
- ICAN Technology guarantees the product quality, but product incompatibility is not in the return or maintain condition.
- Customers don't use the products under the specified electrical performance and environment indicators, no maintain condition.
- Customers change the internal parts.

9.3 Maintenance process

1 Get the maintenance permission.

2 Ship the package to the following address: 4/F, Block B, RuiLian Zhenxing Industrial Park, Wanjiang District, Dongguan City, Guangdong Province.

Tel: 86-0769-22327568

DONG GUAN ICAN TECHNOLOGY CO.,LTD

4/F, Block B, RuiLian Zhenxing Industrial Park, Wanjiang District, Dongguan City, Guangdong Province, China

Tel:0769-22327568 Fax:0769-22327578 Website: ican-tech.en.alibaba.com